



Operation and Maintenance Manual for the
PACE MBT 350[®] Digital
Soldering/Desoldering System
P/N 5050-0552 Rev. C: 3-15
This manual applies to: Version 2.7



INDEX

TITLE	PAGE
General Information	
Introduction	3
Specifications.....	3
EOS / ESD.....	4
Capabilities	4
MBT 350 Compatible Handpieces	4
Handpiece Tips.....	4
Parts Identification.....	5
Safety Guidelines	7
Safety.....	8
Usage Warnings/Cautions	8
Servicing Precautions.....	9
System Set-Up	9
Attaching Tip & Tool Stand	11
Instant Set Back Cubby.....	11
Tip Removal.....	11
Definitions	12
System Power Up	12
LED Operation.....	13
Operation	13
Accessing Programming Menu	13
Password Menu.....	13
Setting Temperature C /F	13
Set Upper Limit.....	14
Set Lower Limit.....	14
Setback Time.....	14
Set Auto Off	14
Scan Enable / Disable	14
THC Calibration Offset Mode Select	15
Set LCD Contrast	15
Set LED Backlite.....	15
Exiting the Programming Menu.....	15
Temperature Adjust Mode.....	16
Setting Channel Offset	16
THC Tip Calibration.....	16
Hello Message.....	17
Corrective Maintenance	17
Packing List.....	18
Spare Parts.....	18
Service	18
LIMITED WARRANTY STATEMENT	19
Contact Information	20

General Information

Introduction

Thank you for purchasing the PACE model MBT 350 Soldering/Desoldering System. This manual will provide you with the information necessary to properly set up, operate and maintain the MBT 350.

Please read this manual thoroughly before using the unit. The MBT 350 system is designed for the most demanding soldering applications. The MBT 350 allows either SENSATEMP or TEMPWISE technology handpieces to be plugged into any of 3, continuously active, handpiece channels. The MBT 350 offers the benefits of SENSATEMP and TEMPWISE in a single system.

PACE's legendary SENSATEMP technology is renowned for its temperature stability and ability to handle high mass applications. For smaller components and when throughput is important, there is TEMPWISE. TEMPWISE is a patented technology that boasts the best response time for high volume applications and easily keeps up in a fast paced environment.

The MBT 350 unit is available in either the 115 VAC or 230 VAC versions. The 230 VAC version system bears the CE Conformity Marking which assures the user that it conforms to all the requirements of (EU) directive EMC 89/336/EEC & 73/23/EEC.

Specifications

POWER REQUIREMENTS

MBT 350 - Version operates on 97-127 VAC, 50/60 Hz.
240 Watts, 2 Amp max, 100% Duty Cycle, Motor on.

MBT 350E - Version operates on 196-253 VAC, 50 Hz.
240 Watts, 2 Amp max, 100% Duty Cycle, Motor on.

PHYSICAL PARAMETERS

Size: 13.5 cm H x 16.5 cm W x 26 cm D (5.3"H x 6.5"W x 10.25"D)

Weight: 5 Kg. (11 Lbs.)

VACUUM AND AIR Measurements at front panel **AUTO SNAP-VAC** and **CONTROLLABLE PRESSURE** Port.

Vacuum Rise Time: Evacuates 200 ms Average as measured with PACE Process Monitor

Vacuum: 26 in. Hg. (Nominal)

Pressure: (4 P.S.I.) (Nominal MAXIMUM setting)

Air Flow: 9 SLPM (0.32 SCFM) MAXIMUM

TEMPERATURE SPECIFICATIONS

Tip Temperature Range: 37-482 °C (100-900 °F) SensaTemp
205-454 °C (400-850 °F) TempWise
Nominal (see note).

Digital Readout Resolution: ±1° (°C or °F)

Tip Temperature Stability: ±1.1°C (2°F) at Idle from Set Tip Temperature.

Temperature Accuracy: Meets or exceeds ANSI JSTD 001

NOTE

Actual minimum and maximum Operating Tip Temperatures may vary depending on handpiece & tip selection.

EOS/ESD

Tip-To-Ground Resistance: Less than 5 ohms.

AC Leakage: Less than 2 millivolts RMS from 50Hz to 500Hz

ENVIRONMENTAL REQUIREMENTS

Ambient Operating Temperature: 0°C to 50°C (32°F to 120°F)

Storage Temperature: -40°C to 100°C (-40°F to 212°F)

Capabilities

All capabilities are dependent upon the use of the appropriate Functional Accessories or Work Aids (refer to Basic Operation section). Available SensaTemp and TempWise handpieces and their associated assembly and repair functions are listed below. An Operations and Maintenance Manual is provided separately with each handpiece which describes the applications and recommended procedures for that particular tool.

The MBT 350 allows either SENSATEMP or TEMPWISE technology handpieces to be plugged into any of 3, continuously active, handpiece channels. The new dual-purpose vacuum/pressure pump and delivery system with PACE's patented SNAP-VAC Technology, provides the most vacuum available for desoldering applications. When used with an air pencil, the high resolution, pressure control valve allows for precise adjustment when working on the smallest components.

MBT 350 Handpieces (Blue Connector)

TD-100 handpiece - The most responsive soldering iron available. Uses tip-heater cartridges. TD-100 Kit P/N 6993-0263-P1 Handpiece only P/N 6010-0147-P1

TD-100N handpiece – A nitrogen compatible version of the TD-100. Requires 6993-0271. TD-100N Kit P/N 6993-0272-P1 Handpiece only P/N 6010-0156-P1

MT-100 handpiece – Tip heater cartridge tweezers for SMD removal. MT-100 Kit P/N 6993-0264-P1 Handpiece only P/N 6010-0148-P1

PS-90 Soldering Iron- Provides a wide range of SMD and thru-hole installation and removal capability as well as unsurpassed thermal performance on heavy, multilayer thru-hole assemblies at safe, lower working temperatures. A wide variety of 3/16" shank, quick change thru-hole and SMD tips (for chip components, SOTs, SOICs and other components) are available. PS-90 Kit P/N 6993-0267-P1 Handpiece only P/N 6010-0150-P1

PS-90N Soldering Iron- A nitrogen compatible version of the PS-90. Requires Nitrogen regulator kit P/N 6993-0271. PS-90N Kit P/N 6993-0274-P1 Handpiece only P/N 6010-0157-P1

SX-80 Sodr-X-Tractor handpiece - Air handpiece ideal for thru-hole desoldering on extra high mass multilayer boards. SX-80 Kit P/N 6993-0266-P1 Handpiece only P/N 6010-0149-P1

TT-65 ThermoTweez handpiece - Performs removal of PLCC (J Leaded), LCCC (leadless) and other surface mount devices. TT-65 Kit P/N 6993-0268-P1 Handpiece only P/N 6010-0151-P1

TJ-80 Mini Thermo Jet handpiece – Foot pedal activated precision air pencil for the installation or removal of SMDs. TJ-80 Kit P/N 6993-0271-P1 Handpiece only P/N 6010-0153-P1

MBT 350 Handpieces tips

A complete list of available handpiece tip is available from your local PACE distributor or online at www.paceworldwide.com.

Parts Identification

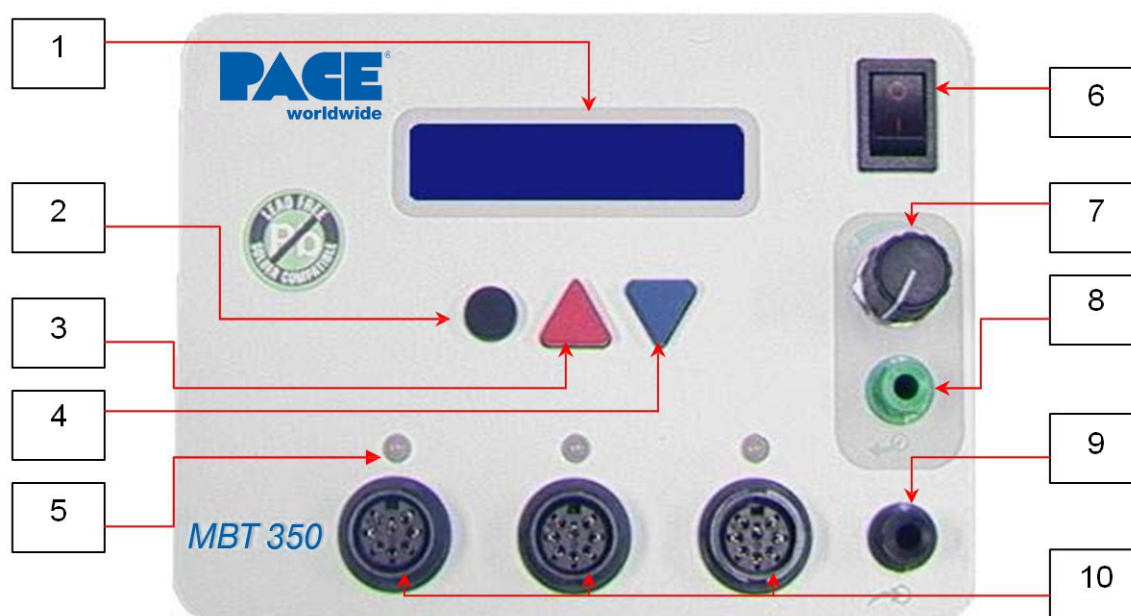

Figure 1

Listed below is a description of the Control Panel features. Use Figures 1 & 2 as a guide.

1. **LCD DISPLAY** - Provides temperature information for all three channels. This includes: Operating Tip Temperature in Temperature Display Mode (normal operation), Tip Offset Constant in Tip Offset Mode, Set Tip Temperature in Tip Set Mode and other information in Calibration (CAL) Mode.
2. **PROGRAM KEY** – Access tip offset feature and scroll through system channels.
3. **SCROLL UP KEY** - Increases the Set Tip Temperature (in Tip Set Mode) and the Tip Offset Constant (in Tip Offset Mode) in one, then ten-degree increments. Also used in (Calibration) Mode.
4. **SCROLL DOWN KEY** - Decreases the Set Tip Temperature (in Tip Set Mode) and the Tip Offset Constant (in Tip Offset Mode) in one then ten-degree increment. Also used in “CAL” (Calibration) Mode
5. **LED**; CH 1, CH 2 or CH 3 Illuminated LED's change color to reflect handpiece connectivity. GREEN (circuit complete) AMBER (in process) RED (no connection / error)
6. **POWER SWITCH** - Turns system ON ("1") and OFF ("0"); controls input power to the system.
7. **PRESSURE ADJUSTMENT** - Controls variable airflow pressure delivery (completely open for optimal pressure).
8. **PRESSURE PORT** – Quick connect fitting with provides airflow for Mini ThermoJet handpiece (in Hot Jet Mode) and Sodr-X-Tractor handpiece. Air pressure is present when handpiece finger switch or optional foot pedal is actuated. Air pressure ceases 1.2 seconds after switch (or foot pedal) is released
9. **AUTO SNAP-VAC PORT** - Quick connect fitting provides quick-rise vacuum for Sodr-X-Tractor, and ThermoPik handpieces. Vacuum is present when handpiece finger switch or optional foot pedal is actuated. Vacuum ceases 1.2 seconds after switch (or foot pedal) released.
10. **CH 1 POWER RECEPTACLE** - Provides power, tip ground, sensing circuitry and finger switch connection from MBT system to handpiece connected to Channel 1 (**CH 1**).
CH 2 POWER RECEPTACLE - Provides power, tip ground, sensing circuitry and finger switch connection from MBT system to handpiece connected to Channel 2 (**CH 2**).
CH 3 POWER RECEPTACLE - Provides power, tip ground, sensing circuitry and finger switch connection from MBT system to handpiece connected to Channel 3 (**CH 3**).

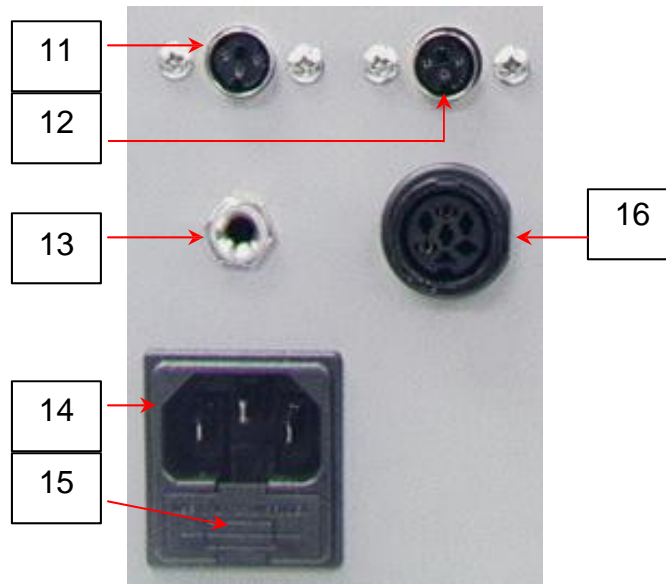

Figure 2

- 11. **INSTANT-SETBACK CUBBY INPUT CHANNEL 1.** Links handpiece on channel 1 to Instant-Setback Cubby. For use with TD-100 handpiece only.
- 12. **INSTANT-SETBACK CUBBY INPUT CHANNEL 2.** Links handpiece on channel 2 to Instant-Setback Cubby. For use with TD-100 handpiece only.
- 13. **EARTH GROUND RECEPTACLE** - Provides positive earth ground to which a ground cable can be connected from the work piece or work surface as part of a static control program.
- 14. **AC POWER RECEPTACLE / FUSE HOLDER** - Receptacle for providing power to the system from AC outlet through power cord. Location of Fuse (F1), which protects system from over current conditions.
- 15. **FUSE** - Provides overload protection for system.
- 16. **FOOT PEDAL RECEPTACLE** - Input for Foot Pedal (optional), which activates vacuum or pressure to the air-operated handpieces.

If you require assistance in the use of this product, contact your local authorized PACE dealer or PACE directly as shown on page 15 of this manual

Safety Guidelines

The following are safety precautions that personnel must understand and follow when using or servicing this product.

1. **POTENTIAL SHOCK HAZARD** - Repair procedures on PACE products should be performed by Qualified Service Personnel only. Line voltage parts may be exposed when the equipment is disassembled. Service personnel must avoid contact with these parts when troubleshooting the product.
2. To prevent personnel injury, adhere to safety guidelines in accordance with OSHA and other applicable safety standards.
3. Handpiece heaters and installed tips are hot when the handpiece is powered on and for a period of time after power off. **DO NOT** touch either the heater or the tip. Severe burns may result.
4. PACE Tip & Tool Stands and handpiece cubbies are designed specifically for use with the associated handpiece and houses it in a manner that protects the user from accidental burns. Always store the handpiece in its holder. Be sure to place the handpiece in its holder after use and allow to cool before storing.
5. Always use PACE systems in a well-ventilated area. A fume extraction system such as those available from PACE are highly, recommended to help protect personnel from solder flux fumes.
6. Exercise proper precautions when using chemicals (e.g., solder paste). Refer to the Material Safety Data Sheet (MSDS) supplied with each chemical and adhere to all safety precautions recommended by the manufacturer.

Safety

PACE adheres to the following Heading Guidelines (based on OSHA guidelines) when listing special information or precautions to be taken. Especially important are all procedures and practices which, if not strictly observed, could result in injury or loss of life. These "NOTES", "CAUTIONS", "WARNINGS" and "DANGERS" are inserted in this manual whenever deemed necessary. They appear in a blocked off form with double outline and a shaded background to highlight the information as shown below.

NOTE

“NOTE”

Used to indicate a statement of company recommendation or policy. The message may relate directly or indirectly to the safety of personnel or protection of property. NOTE is not associated directly with a hazard or hazardous situation and is not used in place of "CAUTION", "WARNING" or "DANGER".

“CAUTION”

Used to indicate a hazardous situation, which may result in minor or moderate injury. May also be used to alert personnel to conditions, procedures and practices which, if not observed, could result in damage to or destruction of the product or other equipment.

“WARNING”

Used to define additional information that if not closely followed might result in serious damage to equipment and represent a potential for serious personnel injury.

“DANGER”

Defines additional information that if not closely followed might result in severe personnel injury or death. Danger is not used for property damage unless personal injury risk is present.

Usage Warnings/Cautions

WARNINGS

1. A fire hazard may arise if the MBT 350 is used improperly.
2. Do not use the MBT 350 in the presence of an explosive atmosphere.
3. Be careful when using the MBT 350 in places where there are combustible materials. Heat may be conducted to combustible materials, which are out of sight.
4. Do not apply heat from the MBT 350 to one place for a long time.
5. Do not leave the MBT 350 unattended while powered on.

CAUTIONS

1. Utilize all standard electrical safety precautions when using this or any other electrical equipment.
2. Always use this system in a well-ventilated area. A fume extraction system such as those available from PACE are highly recommended to protect personnel from solder flux fumes.
5. Exercise proper precautions when using chemicals (e.g., solder paste). Refer to the Material Safety Data Sheet (MSDS) supplied with each chemical and adhere to all safety precautions recommended by the manufacturer.

Servicing Precautions

DANGERS

POTENTIAL SHOCK HAZARD - Repair procedures performed on this product should be performed by qualified service personnel only. Line voltage parts will be exposed when equipment is disassembled. Service personnel must avoid contact with these parts when troubleshooting.

Precautions

The following are general safety precautions that personnel must understand and follow when using or servicing this product. These precautions may or may not be included elsewhere in this manual.

Safety

Electrical Requirements

The MBT 350 unit draws approximately 240 VA (240Watts), which is listed on the nameplate on the power source rear panel. A separate, dedicated AC supply line circuit may be required to adequately power the unit/system. If your power outlet cannot provide suitable power, arrange for a qualified, licensed electrician to install one for you.

System Set-Up

Power Source

Set up the MBT 350 system using the following steps and associated drawings.

1. Remove the MBT 350 from its shipping container(s). Store the shipping container(s) in a convenient location. Reuse of these containers will prevent damage if you ship or store the system.
2. Set the MBT 350 unit on a convenient workbench.
3. Place the **POWER** Switch (on power source front panel) in the "OFF" or "0" position.

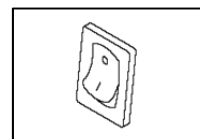

4. Inspect all system components, check for shipping damage, and ensure that all purchased components (standard and options) are present. Use the drawings provided in the following pages as a guide for checking the parts that come with the unit.
5. Assemble Tip & Tool Stands. Attach to the power source if desired. Assembly instructions are enclosed with each Tip & Tool Stand.

6. Connect blue handpiece connector plug(s) to the blue power receptacle(s) **CH 1**, **CH 2** and/or **CH 3** in the following manner. See Fig. 3a.
 - a) With the Connector Key end facing the power source, turn the Locking Ring fully counterclockwise.
 - b) Orient guide on connector with slot of power receptacle.
 - c) Insert connector into power receptacle.
 - d) Turn Locking Ring fully clockwise to lock in place.

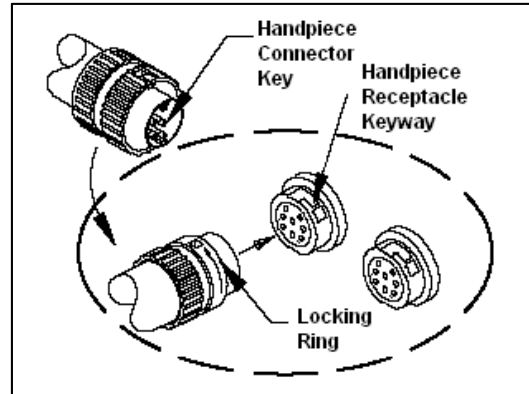

Figure 3a

7. To avoid confusion among handpieces, PACE recommends the use of colored cable markers (P/N 6993-0136 Cable Marker Kit) to identify the particular handpiece. Attach any two like colored markers, one to each end of the handpiece power cable or air hose. Select and use a different colored marker for each handpiece. Labels are also provided to mark Tip & Tool Stands with the name of the associated handpiece.

8. If you have purchased an optional foot pedal, insert the connector plug into the PEDAL Receptacle on the rear panel of the power source. See Fig. 3b. Install additional handpieces and accessories as necessary.
9. Plug the prong end of the power cord into a convenient three wire grounded AC power outlet. The system is now ready for operation.

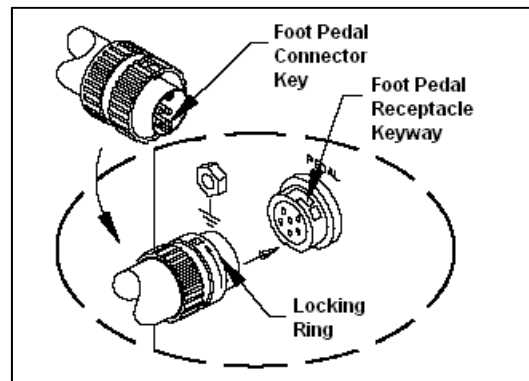

Figure 3b

10. Read the "OPERATION" section of this manual thoroughly before operating the system.

Attaching Tip & Tool Stand to MBT 350

Attach the stand to the power source, using the following procedure. Refer to illustration.

1. Insert the 2 enclosed hex head Mounting Screws into the slot on the side of the Power Source. Some kits may contain 4 mounting screws; 2 with small heads and 2 with large heads. Use the 2 screws that fit properly in the slot. Also, some Power Source cases have more than 1 slot; use the lower slot.
2. Position the Mounting Screws to the rear of the power source and spaced approximately 2 inches apart. Refer to illustration.
3. Place the Tip & Tool Stand beside the power source. Insert ends of the 2 Mounting Screws into the 2 adjacent Tip & Tool Stand mounting holes.
4. Install a Thumb Nut onto the end of each Mounting Screw. Tighten Thumb Nuts to secure the Tip & Tool Stand in position. You may wish to set the Power Source on its side and remove the drip tray to ease installation of the Thumb Nut.
5. Additional Tip & Tool Stands or "cubby's" may be secured to each other by aligning mounting holes on stand sides. Use hex head screws and thumb nuts to mount cubbys together.

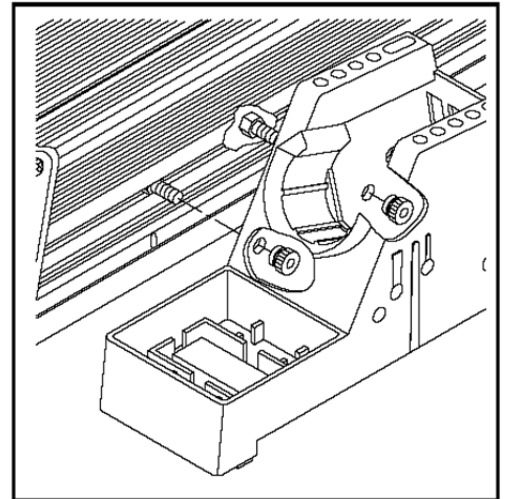

Figure 4

Optional Instant-Setback Cubby

The optional Instant SetBack Cubby is available for use with the MBT 350 and will only function with the TD-100 handpiece. When connected, it automatically puts the system into Setback mode when the TD-100 is placed in the cubby. The Instant Setback Cubby will only function with the TD-100 Handpiece. The MBT 350 is capable of using two Instant Setback Cubbys at the same time. The instant SetBack receptacles are located on the back panel. See figure 3. The instant setback cubby's function is to protect tips, not power off the system. Instant setback is a feature that lowers the temperature to 350°F after 45 seconds of inactivity. At 350°F the solder has solidified so any iron erosion on the tips ceases, protecting the tip.

Tip Removal

WARNING

Never remove a heated tip using bare hands. Use the Hot Grip Rubber Pad or Tip Tool.
Never use a wrench or pliers when removing a handpiece tips.

WARNING:

1. Remove TD-100 and MT-100 handpieces while holding Tip Heater Cartridge with the Rubber Pad; gently pull the THC from handpiece. For PS-90, SX-80, TT-65, and TJ-80 handpieces, loosen heater set screw and remove iron tip with Rubber Pad.
2. Place the tip (still hot) in tip / tool stand.

Definitions

Please read and become familiar with the definitions of each of the following terms that are used repeatedly in the following operational procedures.

Auto-Off: Safety feature that turns power off (1-90 minutes, settable in 1 minute increments) after the system has entered Temperature Setback.

Normal Operation: Normal operating mode of the system in which the Operating Tip Temperature is displayed.

Password: The Password feature of the MBT 350 system will prevent unauthorized alteration of stored system temperature parameters and feature settings. If a Password has been installed, the LED Display will display an instruction to enter the password. Enter a four digit number selected using the scroll up /down keys on the system front panel) when a setting change is attempted.

Programming Menu: The interface used to program the system features parameters (e.g., temperature limits, password, setback time).

Set Tip Temperature: The operator selected idle tip temperature entered into the system memory.

Temperature Adjust Mode: Mode of operation where the Set Tip Temperature may be adjusted.

Temperature Setback: System feature that will independently set back the Set Tip Temperature to 177°C (350°F) after a user selected or preset period of handpiece inactivity.

System Power Up

1. Insert the female end of the power cord into the AC Power Receptacle on the rear panel of the power source.
2. Plug the prong end (male end) of the power cord into an appropriate 3 wire grounded AC supply receptacle.

CAUTION

To insure operator and ESD/EOS safety, the AC power supply receptacle must be checked for proper grounding before initial operation.

LED Operation

The Green colored Temperature LED on the power source front panel indicates System Status.

LED Green - Indicates that the set tip temperature has been reached. Power to the handpiece is cycling Off and On to maintain set temperature.

LED Amber - Continuous power is being delivered to the handpiece. This condition is evident when the system is first powered up (handpiece heater cold) or the Variable Temperature Control setting is increased.



LED Red - No power is being delivered to the handpiece heater. If the LED never illuminates, check for a faulty handpiece heater (see Corrective Maintenance section).

Operation

Accessing Programming Menu

The menu driven LED Display of the MBT 350 system allows you to easily customize your system. By accessing the programming menu, you can:

- Enter, remove or change a Password.
- Set the Default Temperature scale to °F or °C as desired.
- Change the Upper and Lower Temperature limits.
- Enable or disable the Temperature Setback feature.
- Enable or disable the Auto Off feature.
- Change the Default Calibration Offset Option
- Calibration Option 2 LED reset capability
- Enable or disable the Scan feature.
- Enable or disable the display contrast and backlight settings.

To access set up mode, press and hold the PROGRAM Key  while powering on unit. Release key when "Software Version" appears. Pressing the PROGRAM Key  will scroll through each menu option without changing the stored setting.



Follow the MBT 350's on screen prompts to review or set each menu option starting with the password feature.

1. Password Menu





<i>Same</i>	Retains previous password and move to the next step.
<i>Yes</i>	Prompts the operator to enter a new password. Use the scroll up / down keys on the system front panel to select a four digit password. Once password is entered, press the PROGRAM Key  to accept the password and move to the next step. Entering "0000" as a password will disable the password feature.
<i>No</i>	Selecting "NO" bypasses the password feature and moves to the next step.

2. Setting Temperature C /F





The LED Display now shows the stored default Temperature Scale °C or °F temperature shown on the LED Display. Choose one of the following:

- a) Press the PROGRAM Key  to keep the stored default Temperature scale .
- b) Press and release the  UP Key to change the default Temperature Scale. Press and release the PROGRAM Key  to move to the next step.

3. Set Upper Limit





Hit the PROGRAM  key to cycle through different channels, to set channel specific upper limits. Press the  UP and  DOWN button to set the upper temperature limit for the handpiece channels. 900°F (482°C) is the MAXIMUM temperature limit for SensaTemp handpieces. The MAXIMUM temperature for THC handpieces is 850°F (454°C). Press and release the PROGRAM Key  to move to the next step. The upper limit feature will limit the temperature range that an operator may work within. Setting a password will lock out unwanted changes to this feature.

4. Set Low Limit

Hit the PROGRAM  key to cycle through the different channels, to set the channel specific upper Limits. Press the  UP and  DOWN button to set the lower temperature limit for the handpiece Channels. 100°F (37°C) is the MINIMUM temperature for SensaTemp handpieces. The MINIMUM limit for THC handpieces is 400°F(204°C). Press and release the PROGRAM Key  to move to the next step. The lower limit feature will limit the temperature range that an operator may work within. Setting a password will lock out unwanted changes to this feature. Adjusting the working temperature below the set lower limit will turn power off to the selected channel.

5. SetBack Time

Choose one of the following:

- a) Press and release the PROGRAM Key  to keep the currently stored Temperature Setback time.
- b) Press and release the Scroll  UP Key to enable or increase the stored Temperature Setback time. Press and release the PROGRAM Key  to proceed to the next step. Set back may be disabled by entering (00). The maximum set back time is 90 minutes.
- c) Press and release the Scroll Down Key to decrease or enter "00" to disable the stored Temperature Setback time. Press and release the PROGRAM Key  to proceed to the next step.

The LED Display now shows the stored Temperature Setback time in minutes

6. Set Auto Off

Press the  UP Key to enter increase the auto-off time. When enabled, the Auto Off safety system of the MBT 350 system turns off the power to the Handpiece 10- 90 minutes after entering Temperature Setback. When the system has entered Temperature Setback, an Auto Off timer within the system circuitry will start running if Auto Off is turned on. When Auto Off has activated, the LED Display will blink "OFF". To disable the Auto-Off feature, enter "00". If any key is pressed during the selected time out period, the Auto Off timer is reset. The system will return to normal operation. At the end of the time out period, the system will enter Auto Off. Power is turned off to the heater and the LED Display will show a flashing "OFF " and the LED indicator will turn red. Press and release the PROGRAM Key to move to the next step.

7. Scan Enable / Disable

Press and release the Scroll  UP Key to enable or disable the scan mode feature. When enabled the scan feature of the MBT 350 scans each channel and display its information individually for 3 seconds than continually repeats the order. Press and release the PROGRAM Key to move to the next step.



8. THC Calibration Offset Mode Select

When a channel has NOT been calibrated the “C” in channel (“CH”) will display a BLINKING dot in the center of the “C”. See image below:



Channel 1 and 2 have not been calibrated, Channel 3 has been calibrated. The “calibration” indicator will appear in Scan and normal display modes. Additionally, **NO dot** will appear when a SensaTemp handpiece has been connected to the system as it does not require calibration.

- a) Screen will display “Set Offset Mode”
- b) Change the Offset Option by pressing the ▲ UP and DOWN ▼
- c) Choose one of the following options:
 - i. “OS Mode 1” (Offset Mode 1) Offset will clear to zero if either the handpiece or the tip is removed from the system. A BLINKING dot will appear in the center of the “C”.
 - This option could be selected when a variety of different tips are being used and the system should recalibrated after every tip change
 - This option is suitable if replacing the tip or the handpiece would always require the system to be recalibrated
 - ii. “OS Mode 2” (Offset Mode 2) Offset will clear to zero if the handpiece is removed from the system, but removing the tip will maintain the offset. A STEADY dot will appear in the center of the “C” if the tip is removed.
 - This option is desirable when using tips of similar geometry where it is not necessary to formally recalibrate after a tip change.
 - This option would be desirable in situations where supervisors would want to be able to easily determine if the tip has been removed for any reason
 - iii. “OS Mode 3” (Offset Mode 3) Offset will clear to zero if the handpiece is removed from the system, but removing the tip will keep the offset. There will be no dot if the system has an offset. In this mode, the BLINKING dot will only appear if the handpiece is removed (this is the Factory Default Mode).
 - This option could be selected in applications when a the tip is rarely replaced or when the same style tip is used throughout the application
 - This option is suitable if only replacing the handpiece would require the system to be recalibrated
- d) Press and release the PROGRAM Key ● to proceed to the next step.

9. OS Mode reset option – Turn on or off the reset options:



- i) "OS Mode 2 Reset ?= ON:- The line operator/user has the ability to reset the offset indicator by going through the reset sequence. (See resetting the THC Cal indicator below)
 - 1) If a THC handpiece is hooked to the channel being displayed, then pressing the UP ▲ key will rest the calibration indicator/dot
 - 2) If a SensaTemp handpiece is hooked to the channel being displayed then you can cycle to the corresponding channel by holding the program key ● for 5 seconds, and set the offset.
- ii) "OS Mode 2 Reset ?= OFF:
 - a) Under this mode, the access to the reset capability of the Calibration indicator/DOT is not available.

10. Set LCD Contrast

Press the UP ▲ and DOWN ▼ to enter increase or decrease LCD contrast. The range of contrast is 1 to 100. Press and release the PROGRAM Key ● to move to the next step.

11. Set LED Backlite

Press the UP ▲ and DOWN ▼ to enter increase or decrease LCD contrast. The range of backlite is 1 to 100. Press and release the PROGRAM Key ● to move to the next step.

12. Exiting the Programming Menu

The LED Display now reads "End". The Set-Up Mode procedure is now complete. Choose one of the following steps:

- a) Press and release the UP ▲ Key to exit Set-Up Mode and return to normal operation.
- b) Press and release the DOWN ▼ Key to return to the start of the Set-Up Mode procedure.

Temperature Adjust Mode

To increase or decrease handpiece temperature, press the UP ▲ or DOWN ▼ arrow key once. The display will show the current temperature setting for channel "1". Press the UP ▲ or DOWN ▼ arrow keys to increase or decrease handpiece temperature for channel "1". Or press the ● PROGRAM Key to move the next channel. After a period of 10 seconds of inactivity, the display will return to normal operation.

Setting ST Channel Offset or Resetting THC Cal indicator (OS mode 2)

To increase or decrease ST handpiece temperature offset, press the ● PROGRAM Key down for 3 seconds. The display will show the current temperature offset setting for channel "1". Press the UP ▲ or DOWN ▼ arrow keys to increase or decrease offset temperature for channel "1". Or press the ● PROGRAM Key to move the next channel. After a period of 10 seconds of inactivity, the display will return to normal operation.

THC Tip Calibration

To enter Calibration mode: Press and hold the ● PROGRAM Key and the ▲ UP keys while

powering on unit. Release keys when “Software Version” appears. Follow the instructional prompts to review or set each menu option. Follow the procedure below.

Calibration Instructions

The steps for the procedure are:

1. Turn on the system.
2. Clear any offset from the system by disconnecting the handpiece from the system. Re-connect the handpiece and proceed to step 2.
3. A BLINKING dot will appear in the center of the "C" in channel (“CH”). Set the MBT 301 to 700°F to (370°C).
4. Measure the actual temperature of the tip from your temperature verification device. Note results.
5. Turn off the system.
6. Enter Calibration mode: Press and hold the ● PROGRAM Key and the ▲ UP key while turning the system on. Release both keys when the display reads version 1.2 or higher.
7. The display will now read Channel “1” System Cal? Press the ▲ UP or ▼ DOWN key to enter the measured temperature from step 4 for channel “1”. For example, your temperature verification device reads 695 °F. Scroll through until the display reads 695. Press ▼ key / NO to move to the next channel.
8. Press the ● PROGRAM Key to save calibration and move to the next channel. Upon exiting, LED will illuminate green and the display will return to normal operation mode.
9. See calibration options in the THC Calibration Offset Mode Select section of the manual.

NOTE

Before calibration is attempted, the system should be allowed to reach set temperature and stabilize for at least 15 seconds before calibrating.

Corrective Maintenance

Power Source

Refer to the table below. Most malfunctions are simple and easy to correct.

Symptom	Probable Cause	Solution
No power to system	Blown Fuse	Inspect and replace the fuse(s) located on the power source rear panel
	Line cord unplugged	Plug line cord into the appropriate AC outlet
Heater Assembly does not heat	Open Heater	Contact PACE for assistance
Little or no air flow, heater heats and blower is running	Kinked air hose	Change routing of air hose to remove kinks
Little or no vacuum	Worn vacuum pump	Replace vacuum pump. Contact PACE for assistance.
Vacuum Cup will not hold component	Worn or broken vacuum cup	Replace vacuum cup
Vacuum Pickup Rod binding	Vacuum Pickup rod is bent	Contact PACE for assistance

Packing List

Item #	Description	Part Number	MBT 350 Only	MBT 350 E	MBT 350 System	MBT 350 E System
1	System Power Supply	8007-0452	1	0	1	0
2	System Power Supply	8007-0453	0	1	0	1
3	Power Cord, 115V	1332-0094-P1	1	0	1	0
4	Power Cord, 230V	1332-0093-P1	0	1	0	1
5	Hot Grip Removal Pad	1100-0307-P1	0	0	1	1
6	Fiber Cleaning Tool	1100-0232	0	0	1	1
7	Cleaning Sponge Tool	1100-0233	0	0	1	1
8	Wire Brush 3/16 Diameter	1127-0014	0	0	1	1
9	Cable Marker Kit	6993-0136-P1	0	0	1	1
10	Angle Bracket Kit	6018-0097-P1	0	0	1	1
11	PACE Screwdriver	1100-0230	0	0	1	1
12	SX-80 (Blue Connector) Kit	6993-0266-P1	0	0	1	1
13	MT-100 ((Blue Connector)	6993-0264-P1	0	0	1	1
14	TD-100 (Blue Connector) Kit	6993-0264-P1	0	0	1	1
15	Operations Manual CD	5050-0459	0	0	1	1

Spare Parts

Item #	Description	PACE Part Number
1	Fuse, 2.0 A, 125 V, Lag Time (MBT 350)	1159-0275-01
2	Fuse, 1.25 A, 230 V, Lag Time (MBT 350E)	1159-0275-02

Service

Please contact PACE or your local distributor for service and repair.

PACE WORLDWIDE LIMITED WARRANTY

PACE warrants to the first user that products manufactured by it and supplied hereunder are free of defects in materials and workmanship for a period of one (1) year from the date of receipt by such user. This Warranty as applied to blowers and motor pumps is limited to a period of one (1) year. Monitors, computers and other brand equipment supplied but not manufactured by PACE are covered under their respective manufacturer's warranty in lieu of this Warranty.

This warranty does not cover wear and tear under normal use, repair or replacement required as a result of misuse, improper application, mishandling or improper storage. Consumable items such as tips, heaters, filters, etc. which wear out under normal use are excluded. Failure to perform recommended routine maintenance, alterations or repairs made other than in accordance with PACE's directions, or removal or alteration of identification markings in any way will void this warranty. This warranty is available only to the first user, but the exclusions and limitations herein apply to all persons and entities.

PACE MAKES NO OTHER WARRANTY, EXPRESS OR IMPLIED, AND MAKES NO WARRANTY OF MERCHANTABILITY OR FITNESS FOR A PARTICULAR PURPOSE.

PACE will, at its option, repair or replace any defective products at its facility or other location approved by it at no charge to user, or provide parts without charge for installation by the user in the field at user's expense and risk. User will be responsible for all costs of shipping equipment to PACE or other location for warranty service.

EXCEPT FOR THE REMEDY ABOVE DESCRIBED, UNLESS OTHERWISE REQUIRED BY APPLICABLE LAW, PACE WILL HAVE NO OTHER OBLIGATION WITH REGARD TO ANY BREACH OF WARRANTY OR OTHER CLAIM WITH RESPECT TO THE PRODUCTS, OR LIABILITY FOR ANY DIRECT, INDIRECT, CONSEQUENTIAL, OR INCIDENTAL LOSS OR DAMAGE CAUSED BY OR OCCURRING IN CONNECTION WITH ANY OF THE PRODUCTS.

Warranty service may be obtained by contacting the appropriate PACE Company or local Authorized PACE distributor as set forth below to determine if return of any item is required, or if repairs can be made by the user in the field.

Defective products may not be returned to PACE without a Service Authorization ("SA") Number.

Any warranty or other claim with respect to the products must be made in writing delivered to PACE (or local Authorized PACE distributor for Buyers outside the USA and the United Kingdom) within a reasonable time of the expiration date of this warranty with sufficient evidence of purchase and date of receipt, otherwise user's rights under this warranty shall be deemed waived.

PACE Incorporated retains the right to make changes to specifications contained herein at any time, without notice. Contact your local authorized PACE Distributor or PACE Incorporated to obtain the latest specifications.

The following are trademarks and/or service marks of PACE, Incorporated, NC, USA:

INSTACAL™, FUMEFLO™, HEATWISE™, PACEWORLDWIDE™, PERMAGROUND™, POWERPORT™, POWERMODULE™, TEMPWISE™, TIP-BRITE™, AUTO-OFF™, and TEKLINK™.

The following are registered trademarks and/or service marks of PACE Incorporated, Southern Pines North Carolina U.S.A.

ARM-EVAC®, FLO-D-SODR®, MINIWAVE®, PACE®, SENSATEMP®, SNAP-VAC®, SODRTEK®, SODR-X-TRACTOR®, THERMOFLO®, THERMOJET®, THERMOTWEEZ®, VISIFILTER®, THERMO-DRIVE®, and TOOLNET®.

PACE products meet or exceed all applicable military and civilian EOS/ESD, temperature stability and other specifications including MIL STD 2000, ANSI/JSTD 001, IPC7711, and IPC A-610.

For PACE USA Customers:

PACE, INCORPORATED
255 Air Tool Drive
Southern Pines,
North Carolina, 28387
Tel: (877) 882-PACE
Tel: (910) 695-7223
Fax: (910) 695-1594

For PACE EUROPE Customers:

PACE EUROPE LIMITED
13 Tanners Drive, Blakelands
Milton Keynes
MK1 45BU
United Kingdom
Tel. (44) 1908 277666
WARRANTY SERVICE FAX: (44) 1908 277 777



www.paceworldwide.com

www.facebook.com/paceworldwide