



## Operation and Maintenance Manual for WJS 100 Soldering System(s)

P/N 5050-0574 VER 2.0



### This manual applies to:

Model	Part Number
WJS-100	8007-0558
WJS-100/E	8007-0559
WJS-100 w/ ISB	8007-0560
WJS-100/E w/ ISB	8007-0561

TITLE	PAGE
<b>General Information</b>	
Introduction .....	3
Specifications .....	3
Power Source Requirements .....	3
Temperature Specifications .....	3
EOS/ESD Specifications .....	3
Power Supply Features.....	3
<b>Safety</b>	
Safety Guidelines .....	4
<b>System Set-Up</b>	
Mounting Options .....	4
Tip & Tool Stand Mounting Options .....	5
Handpiece Connection.....	5
System Power Up .....	5
<b>Operation</b>	
Digital Control LED Operation .....	6
LED Display .....	6
THC Tip Calibration .....	7
Customizing Your System.....	8
Introduction .....	8
Entering Set-Up Mode.....	8
Password .....	8
Temperature Scale .....	8
Temperature Limits .....	8
Temperature Setback.....	9
Auto Off .....	9
THC Calibration Offset Mode .....	10
Exiting Set-Up Mode.....	10
Default Factory Settings .....	11
Available Tips.....	11
<b>System Calibration</b> .....	11
<b>Corrective Maintenance</b> .....	12
<b>Spare Parts</b> .....	12
<b>Service</b> .....	12
<b>PACE LIMITED WARRANTY STATEMENT</b> .....	13

## General Information

### Introduction

Thank you for purchasing the WJS 100 Soldering System. This manual will provide you with the information necessary to properly set up, operate, and maintain your system. Please read this manual thoroughly before using the system.

The systems featured in this guide are available in either 115 VAC or 230 VAC versions. All of these models incorporate Intelliheat™ technology. The 230 VAC version system bears the CE Conformity Marking, which assures the user that it conforms to EMC 89/336/EEC. All models featured in this manual are lead free compatible and comply with RoHS and WEEE directives.

### Specifications

WJS-100	Operates on 97-127 VAC, 50/60Hz, 120 Watts maximum at 115 VAC, 60Hz	WJS-100/E	Operates on 197-253 VAC 50/60Hz, 120 Watts maximum at 230 VAC, 50Hz
---------	---	-----------	---

### Temperature Specifications (All Models)

Tip Heater Cartridge Handpiece Tip Temperature Range: 205 to 455°C (400 to 850°F) nominal.

Digital Readout Resolution: ±5° (°C or °F)

Tip Temperature Stability: ±1.1°C (2°F) at Idle from Set Tip Temperature.

Temperature Accuracy: Meets or exceeds ANSI JSTD 001

### EOS/ESD Specifications (All Models)

Tip-To-Ground Resistance: Less than 2 ohms.

AC Leakage: Less than 2 Millivolts RMS from 50Hz to 100MHz.

Transient Level: Less than 500mV peak, out to 100MHz.

## Power Supply Features

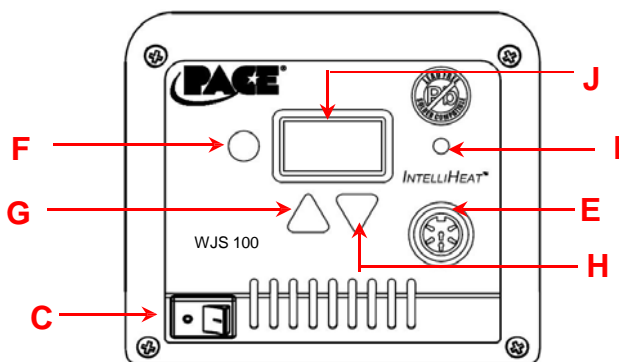

ST 50

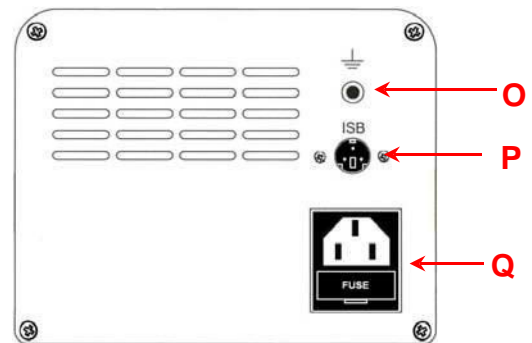

	Feature	Description
C	Power switch	On /off control of power supply.
E	Power Receptacle	Front panel connection of handpiece.
F	Program button	For access and confirmation of program menu functions.
G	Up arrow button	Increase set temperature and scroll through program menu functions.
H	Down arrow button	Decrease set temperature and scroll through program menu functions.
I	Digital control LED	Indicates status of power supply.
J	Digital display	Displays temperature setting and menu functions.
O	Ground jack	For ground system to static safe work area.
P	ISB connection	Connection for Instant Set Back cubby.
Q	Power inlet with fuse	Connection for IEC power cord and fuse replacement.

### **Safety Guidelines**

The following are safety precautions that personnel must understand and follow when using or servicing this product.

- 1. POTENTIAL SHOCK HAZARD** - Repair procedures on PACE products should be performed by Qualified Service Personnel only. Line voltage parts may be exposed when the equipment is disassembled. Service personnel must avoid contact with these parts when troubleshooting the product.
- All handpiece heaters and installed tips are hot when the handpiece is powered on and for a period of time after power off. **DO NOT** touch either the heater or the tip. Severe burns may result.
- PACE Tip & Tool Stands and handpiece cubbies are designed specifically for use with the associated handpiece and houses it in a manner that protects the user from accidental burns. Always store the handpiece in its holder. Be sure to place the handpiece in its holder after use and allow heater / tip to cool before storing.
- Always use PACE systems in a well-ventilated area. A fume extraction system such as those available from PACE are highly, recommended to help protect personnel from solder flux fumes.
- Exercise proper precautions when using chemicals (e.g., solder paste). Refer to the Material Safety Data Sheet (MSDS) supplied with each chemical and adhere to all safety precautions recommended by the manufacturer.

### **System Set-Up**

Set up the Intelliheat™ system using the following steps.

1. Store the shipping container in a convenient location. Reuse of these containers will prevent damage if you store or ship your system.
2. Place the Power Switch in the “OFF” or “0” position.

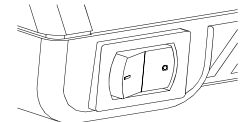

### **Mounting Options**

The power supply can be placed directly on a workbench or it also can also be mounted under a workbench or shelf to conserve space (**optional mounting P/N 1321-0609-P1 bracket sold separately**). To mount the system in this way:



1. Mount the bracket in the desired location (fasteners not supplied).
2. Insert the 2 Mounting Screws (head first) into the power source mounting slots.
3. Place the washers over the screws.
4. Fit the power source between the bracket's support arms and place the screws into the slots on the support arms.
5. Place the nut on the screw and tighten by hand.
6. Angle the power source so the operator can see the front panel easily.
7. Tighten the nuts with a wrench or pliers.

### Handpiece Connection

***The WJS 100 is designed to work with Intelliheat compatible TD-100 Thermo-Drive® Soldering handpieces and WJS 100 Tip heater Cartridges with the gold end connector. Using other handpieces or tips may damage your WJS system or the tips/handpieces.***

Connect the handpiece connector plug into the Power Receptacle in the following manner.

1. Align guide on connector with slot on power receptacle.
2. Insert connector into power receptacle.
3. Turn the connector housing clockwise to lock in place.

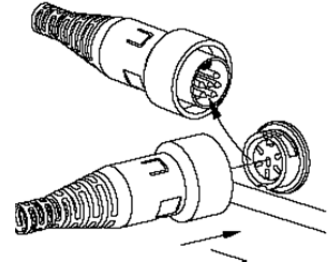

### Instant Setback Cubby Connection

If you purchased the system with the Instant Setback Cubby, please follow the directions in the box with the ISB Cubby to connect it to the system.

### System Power Up

1. Insert the female end of the power cord into the AC Power Receptacle on the rear panel of the power source.
2. Plug the prong end (male end) of the power cord into an appropriate 3 wire grounded AC supply receptacle.

### Setup and Operation

#### Operation

1. Ensure that the Set-Up procedure has been performed. Check for the following:
  - a) Handpiece connection to the power source.
  - b) Proper tip installed in handpiece.
  - c) Power cord connection between an appropriate AC supply and the power source.
2. Turn the Power Switch On ("I").
3. Press the Scroll Up (▲) Key. The Set Temperature is now displayed, immediately perform step 4. If a Password has been previously programmed into the system, "EPO" will be appear on the LED Display at this point. When this message appears, the operator must enter the correct Password before adjusting the temperature.
4. Adjust the temperature by pressing and holding Scroll Up (▲) Key or Scroll Down (▼) key. Observe the display as the Set Temperature increases first in increments of 5° and then in increments of 10°. When the desired temperature is reached, release the key.

**NOTE:** The Set Temperature can only be adjusted within the defined temperature limits. If the upper limit has been reached, the display will read "HiL", if the Lo limit is reached, the display will read "OFF". Temperature limits can be adjusted in the Set-Up menu

5. An offset may be entered if using **ST** massive tips. To enter an offset, simply press the program key **for 3 seconds** while the system is in normal operation mode and enter the offset using the keypad. The display will return to normal display mode in 5-7 seconds.

### **Digital Control LED Operation**

The colored LED on the power source front panel indicates calibration status.

**LED Full On Red** – A fault has occurred. Check handpiece and/or tip heater cartridge. Check handpiece connection to front panel.

**LED Full On Green** – Calibration of THC handpiece is complete or SensaTemp handpiece is connected

**LED Full On Amber** – Calibration has not been cleared but tip has been removed (Offset Control 2)

**LED Blinks Amber** – Calibration has not been completed or has been cleared (THC irons)

**LED Off** - Unit is in setback or Instant Set Back (ISB cubby) is activated.

### **LED Display, Normal Operation**

The LED Display provides a 3-digit display of temperature information. The LED Display will show:

1. A display of "888" on initial power up to ensure that all LEDs on the display are working.
2. A display of the software version of the installed microprocessor (e.g., "1-9") for 2 seconds on initial power up after the "888" is displayed.
3. Actual tip temperature of the connected handpiece during normal operation.
4. The tip temperature displayed will flash when the system is in Temperature Setback.
5. The displayed temperature will decrease and stabilize at 177°C (350°F) when the system is in Temperature Setback.
6. "OFF" with stable display when the Set Tip Temperature has been set to Off (below minimum set tip temperature).
7. "OFF" with flashing display when the unit has entered Auto Off. Refer to the "Set-Up Mode" portion of this manual.
8. Error messages ("CHP", "SSE" or "OCE") if a system fault is detected. Refer to the "Corrective Maintenance" portion of this manual.



## LED Display, Temperature Adjust Mode

The LED Display will show the following when adjusting the desired Set Tip Temperature.

1. The Set Tip Temperature.
2. "HiL" (High Temperature Limit) when adjusting the set tip temperature and the maximum allowable temperature is exceeded. Refer to the "Set-Up Mode" portion of this manual.
3. "OFF" (Low Temperature Limit) when adjusting the set tip temperature and the minimum allowable temperature is exceeded. Refer to the "Set-Up Mode" portion of this manual.
4. "EP" will be displayed if a Set Tip Temperature adjustment is attempted and a Password has been stored in system memory. As the Password is entered, the zero will increase by one as each key entry is made.
5. "no" will be displayed if the entered password does not match the stored Password.







## THC Tip Calibration

To enter Calibration mode: Press and hold the Program Key (  ) and the Scroll up Key (  ) while turning on the Power Switch ("I" position). Release keys when the software version appears. Follow the procedure below.

### Calibration Instructions

The steps for the procedure are:

1. Turn on the system.
2. Clear any offset from the system by disconnecting the handpiece from the system. Re-connect the handpiece and proceed to step 2.
3. LED should go to amber. Set to 700°F to (370°C).
4. Measure the actual temperature of the tip from your temperature verification device. Note results.
5. Turn off the system.
6. Enter Calibration mode: Press and hold the Program Key (  ) and the Scroll up Key (  ) while turning on the Power Switch ("I") position. Release both keys when the software version appears.
7. The display will now read "tIP". Press the Scroll UP Key (  ) or DOWN Key (  ) to enter the measured temperature from step 4. For example, your temperature verification device reads 695 °F. Scroll through until the display reads 695.
8. Press the Program Key (  ) to save calibration. Upon exiting, LED will illuminate green and the display will return to normal operation mode.
9. See calibration display options in the THC Calibration Offset Mode Select section of the manual

## Customizing Your System

### Introduction

The menu driven LED Display of the systems allows you to easily customize your system. In Set-Up Mode, you can:

- Enter, remove or change a Password.
- Set the Default Temperature scale to °F or °C.
- Change the Upper and Lower Temperature limits.
- Enable or disable the Temperature Setback feature and adjust the time-out period (if enabled).
- Enable or disable the Auto Off feature and adjust the time-out period (if enabled).
- Change the Default Calibration Offset Option.

### Entering the Set-Up Menu

The following instructions should be performed to familiarize the operator with the system.

1. Place Power Switch in the "OFF" ("0") position.
2. Press and hold the Program Key (  ) while turning on the Power Switch ("1" position).

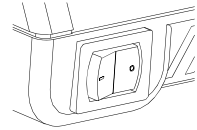

### Password

3. The LED Display will display the version of the microprocessor and change to read "P--" or "EP".
  - a) If the display reads "EP", a Password has been stored in system memory. The password must be entered to access into the menu. If the wrong password is entered, "no" will appear on the display and the system will return to normal operation. If this occurs, repeat steps 1 & 2 and enter the correct Password.
    - b) The LED Display reads "P--". Choose one of the following options:
      - i. Press the Program Key (  ) to keep the currently stored Password (including no Password).
      - ii. To enter a password, select a 3 digit number as the password using the keypad. (1 to 999). Make a note of the entered Password.

### Temperature Scale

4. The LED Display now shows the stored default Temperature Scale (°C or °F temperature shown on LED Display). Choose one of the following:
  - a) Press the Program Key (  ) to keep the stored default Temperature Scale.
  - b) Use the keypad to change the default Temperature Scale.
  - c) Press and release the Program Key to proceed to the next step



### Temperature Limits

5. The LED Display now shows the stored default High ("Hi") Temperature Limit with the display alternating to show "Hi" and the stored limit. Choose one of the following:
  - a) Press and release the Program Key (  ) to keep the stored High Temperature Limit.
  - b) Adjust the stored High Temperature Limit using the keypad
  - c) Press and release the Program Key to proceed to the next step.
6. The LED Display now shows the stored default Low ("Lo") Temperature Limit with the display alternating to show "Lo" and the stored limit. Choose one of the following:

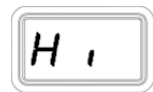



- a) Press and release the Program Key (  ) to keep the stored Low Temperature Limit.
- b) Adjust the stored Lo Temperature Limit (up to 482°C, 900°F) using the keypad.
- c) Press and release the Program Key to proceed to the next step.

### Temperature Setback

7. The LED Display now shows the stored Temperature Setback time as "S-X" (x=0 thru 9). Time is shown as tens of minutes (e.g., "S-3" equals 30 minutes). A display of "S-0" indicates that Setback is disabled. Choose one of the following:

- a) Press and release the Program Key (  ) to keep the currently stored Temperature Setback time.
- b) Adjust the stored Temperature Setback value using keypad.
- c) Press and release the Program Key to proceed to the next step.



To preserve tip life and save energy, the system can be programmed to automatically set back its Tip Temperature to 177°C (350°F) after a selected period of handpiece inactivity (adjustable 10- 90 minutes in Set-Up Mode). As received from the factory, this feature is enabled. There are 2 ways to exit Temperature Setback Mode:

- 7A1. Press and release Scroll up Key (▲).
- 7A2. Cycle the Power Switch.

Set Tip Temperature and Tip Offset values will be simultaneously restored. For optimum performance, do not attempt to use the attached handpiece until the Set Tip Temperature is achieved.

### Auto Off

8. The LED Display now shows the stored Auto Off time as "AOx" (x=0 thru 9). Time is shown as tens of minutes (e.g., "AO8" equals 80 minutes). A display of "AO0" indicates that Auto Off is disabled. Choose one of the following:

- a) Press and release the Program Key (  ) to keep the currently stored Auto Off time.
- b) Adjust the Auto Off value using the keypad.
- c) Press and release the Program Key to proceed to the next step.



- 8A. When enabled, the Auto Off safety feature turns off the power to the handpiece 10- 90 minutes after entering Temperature Setback. When the system has entered Temperature Setback, an Auto Off timer within the system circuitry will start running.

- 8A1. If any key is pressed during the selected time out period, the Auto Off and Setback timers are reset. The system will return to normal operation.
- 8A2. At the end of the time out period, the system will enter Auto Off. Power is turned off to the heater and the LED Display will show a flashing "OFF".

- 8B. Exiting Auto Off: Auto Off can be exited; returning to normal operation by:
  - 8B1. Pressing and releasing a Key (either of the 3 keys), or
  - 8B2. By turning the Power Switch OFF ("0") and then back ON ("1").

## THC Calibration Offset Mode Select

9. The LED Display now shows the Calibration Offset Options as "OCx" (x=1 thru 3).
  - a) Change the Offset Option by pressing Scroll Up (▲) Key or Scroll Down (▼) key.
  - b) Choose one of the following options:
    - i. "OC1" (Offset Control 1) Offset will clear to zero if either the handpiece or the tip is removed from the system. LED will change from Green to BLINKING Amber in either case.
      - This option could be selected when a variety of different tips are being used and the system should recalibrated after every tip change
      - This option is suitable if replacing the tip or the handpiece would always require the system to be recalibrated
    - ii. "OC2" (Offset Control 2) Offset will clear to zero if the handpiece is removed from the system, but removing the tip will maintain the offset. LED will change from Green to BLINKING Amber if the handpiece is removed, and will change to SOLID Amber if the tip is removed.
      - This option is desirable when using tips of similar geometry where it is not necessary to formally recalibrate after a tip change.
      - This option would be desirable in situations where supervisors would want to be able to easily determine if the tip has been removed for any reason
    - iii. "OC3" (Offset Control 3) Offset will clear to zero if the handpiece is removed from the system, but removing the tip will keep the offset. The LED will remain Green if the system has an offset. In this mode, the LED will change from Green to BLINKING Amber only if the handpiece is removed.
      - This option could be selected in applications when a the tip is rarely replaced or when the same style tip is used throughout the application
      - This option is suitable if only replacing the handpiece would require the system to be recalibrated
  - c) Press and release the Program Key (  ) to proceed to the next step.
10. If you selected "OC2" (Offset Control 2), then you are greeted with one additional option L-0 and L-1, which implies that the reset to the LED is either ON (1) or OFF (0)
  - i. If you select L-0, (Off), the LED will not reset back to Green without a full calibration.
  - ii. If you select L-1, (On), then
    - a) If the tip is removed, the LED goes to SOLID amber, and the calibration is not lost. If you hold the program key for 5 seconds, the LED goes back to green, and you never lost the calibration.
    - b) If the hand piece is removed, the LED goes to blinking amber, and the calibration is lost then the unit would have to be calibrated again ((kindly refer to THC tip calibration on page7)

## Exiting Set-Up Mode

11. The LED Display now reads "End". The Set-Up Mode procedure is now complete. Choose one of the following steps:
  - a) Press and release the Scroll Up (▲) Key to exit Set-Up Mode and return to normal operation.
  - b) Press and release the Scroll Down (▼) Key to return to the start of the Set-Up Mode procedure. Go back to step 4.

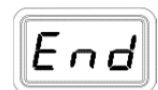

## Default Factory Settings

The WJS-100 system comes equipped with a number of features, which may be adjusted by the user. Listed below are the features and default settings of each. To change and/or learn about any of these features, refer to the applicable part of the “Customizing Your System” section of this manual.

Feature	Factory Setting
Password	None Entered
Default Temperature Scale (°C/°F)	°F for 115 VAC Systems °C for 230 VAC Systems
“HI” (Upper) Temperature Limit	427 °C (800 °F)
“LO” (Lower) Temperature Limit	260 °C (500 °F)
Set Temperature	371 °C (700 °F)
Tip Offset Constant	“0”
Temperature Setback	Enabled, 30 minutes
Auto Off	Enabled, 60 minutes
Calibration Offset	“OC3”

Available Tips – ONLY USE 1128 SERIES TIPS with GOLD END CONNECTORS	
1128-0001-P1	WJS High Performance TIP, 1/32" Conical Sharp Extended
1128-0002-P1	WJS High Performance TIP 1/64" Conical Sharp
1128-0003-P1	WJS High Performance TIP 1/64" Conical, Sharp, Bent 30 Degree
1128-0008-P1	WJS High Performance TIP 3/64" 30 Degree Chisel
1128-0010-P1	WJS High Performance TIP 13/64" Chisel
1128-0012-P1	WJS High Performance TIP 1/32" 30 Degree Chisel
1128-0013-P1	WJS High Performance TIP 3/32" 30 Degree Chisel
1128-0019-P1	WJS High Performance TIP 1/16" 30 Degree Chisel
1128-0032-P1	WJS High Performance TIP MINIWAVE
1128-0037-P1	WJS High Performance TIP 0.25" Knife Blade

## System Calibration

All systems are tested for temperature accuracy at the factory and can be checked for calibration according to requirements. No internal adjustments can be made to the power supply.





### To Adjust Digital Temperature Control Systems

1. After the system/tip has stabilized, measure the tip temperature with whatever method you use.
2. Turn off power source and turn it back on while holding down the program (round) key and the up key.
3. The system will prompt you to enter the measured temperature using the keypad.
4. Press the program key and the system will restart.
5. To clear the calibration, remove the handpiece while the power source is ON.

## Corrective Maintenance

### Digital Display Message Codes

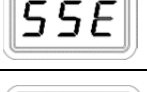
Listed below are message codes, which, may be shown on the LED Display if a mistake were to be made by the operator (e.g., wrong Password entry) or if the system has malfunctioned.

LED Display Message	Description
	The incorrect password has been entered. The displayed message will time out after 6 seconds and revert to normal operation. Enter the correct password.
	“Check Handpiece” No handpiece is connected to the power receptacle. Connect handpiece
	“Open Sensor Error” The handpiece heater assembly sensor is open. Refer to the appropriate handpiece manual (ST Products Only).
	“Shorted Sensor Error” The handpiece heater assembly sensor is shorted. Refer to the appropriate handpiece manual.
	“Over Circuit Error” The handpiece heater assembly may be defective. Refer to the appropriate handpiece manual Contact PACE or your authorized local representative for assistance.

### Power Source

Most malfunctions are simple and easy to correct.

Symptom	Probable Cause	Solution
No power to system	Blown Fuse	Check handpiece using Heater Assembly Checkout Procedures in the appropriate handpiece manual. Replace the fuse (located in the AC Receptacle Fuse Holder) with one of the same rated value (see Table 4, Spare Parts)
Handpiece will not heat	Defective Heater	Refer to the appropriate handpiece manual
	Power Source Malfunction	Contact PACE

### Spare Parts

Item #	Description	PACE Part Number
1	Fuse, 1.25 Amp Time Lag (Domestic)	1159-0251-P5
	Fuse, 0.63 Amp Time Lag (Export Models)	1159-0214-P5

### Service

Please contact PACE or your local distributor for service and repair.

## **PACE LIMITED WARRANTY STATEMENT**

### **Limited Warranty**

Seller warrants to the first user that products manufactured by it and supplied hereunder are free of defects in materials and workmanship for a period of one (1) from the date of receipt by such user. This Warranty as applied to blowers and motor pumps is limited to a period of six (6) months. Other brand equipment supplied but not manufactured by PACE are covered under their respective manufacturer's warranty in lieu of this Warranty.

This warranty does not cover wear and tear under normal use, repair or replacement required as a result of misuse, improper application, mishandling or improper storage. Consumable items such as tips, heaters, filters, etc. which wear out under normal use are excluded. Failure to perform recommended routine maintenance, alterations or repairs made other than in accordance with Seller's directions, or removal or alteration of identification markings in any way will void this warranty. This warranty is available only to the first user, but the exclusions and limitations herein apply to all persons and entities.

**SELLER MAKES NO OTHER WARRANTY, EXPRESS OR IMPLIED, AND MAKES NO WARRANTY OF MERCHANTABILITY OR FITNESS FOR A PARTICULAR PURPOSE.**

Seller will, at its option, repair or replace any defective products at its facility or other location approved by it at no charge to user, or provide parts without charge for installation by the user in the field at user's expense and risk. User will be responsible for all costs of shipping equipment to Seller or other location for warranty service.

**EXCEPT FOR THE REMEDY ABOVE DESCRIBED, UNLESS OTHERWISE REQUIRED BY APPLICABLE LAW, SELLER WILL HAVE NO OTHER OBLIGATION WITH REGARD TO ANY BREACH OF WARRANTY OR OTHER CLAIM WITH RESPECT TO THE PRODUCTS, OR LIABILITY FOR ANY DIRECT, INDIRECT, CONSEQUENTIAL, OR INCIDENTAL LOSS OR DAMAGE CAUSED BY OR OCCURRING IN CONNECTION WITH ANY OF THE PRODUCTS.**

Warranty service may be obtained by contacting the appropriate PACE Company or local Authorized PACE distributor as set forth below to determine if return of any item is required, or if repairs can be made by the user in the field. Any warranty or other claim with respect to the products must be made with sufficient evidence of purchase and date of receipt, otherwise user's rights under this warranty shall be deemed waived.

PACE Contact information:

For PACE USA Customers:

PACE Worldwide  
255 Air Tool Drive  
Southern Pines, NC 28387  
phone 1.877.882.PACE  
fax 910.695.1594

For PACE EUROPE Customers:

PACE Europe Limited  
11 Holdom Avenue  
Bletchley, Milton Keynes,  
Buckinghamshire, MK1 1QU (UK)  
phone +44 1908 277666  
fax +44 1908 277777

All other Customers:

Local Authorized PACE Distributor